

JX 1-180 T10 NT20



Electric - Qmax 25 m³/h - 416 l/min (110 USgpm) - Hmax 37 m (121 ft)

Code not yet assigned



Indicative picture of the product

Product Data

Suction port
Threaded - 1 1/2" ISO 228 (BSP)

Delivery port
Threaded - 1 1/2" ISO 228 (BSP)

Qmax
25 m³/h - 416 l/min (110 USgpm)

Hmax
37 m (121 ft)

Solids handling
11 mm (0.4")

Motor power
4 kW - 5,5 HP

Motor type
**IEC standard
Cast iron frame**

Motor brand
CEMP

Weight
110 kg (243 lb)

Close-coupled self-priming centrifugal pump with electric motor

Characteristics

The J series self-priming centrifugal pumps are used in applications where a rapid priming capacity is required from demanding suction heights combined with the ability to transfer and manage polluted fluids, dirty and abrasives with suspended large diameter solids. The system is based on an inspectable pump casing which also acts as a water tank allowing a first quick priming without auxiliary systems, simplifying management of the system and reducing the time for maintenance. Within the physically permitted suction height limits, J pumps are a more comfortable and reliable solution than submersible pumps and vertical submersed impeller pumps. JX pumps include a thermocouple for back-sealing quench fluid temperature measurement. The pumping units in accordance with Directive 2014/34 / EU, have the following identification marking:

  II 2/2 G Ex IIB T5...T3 Gb X

Benefits

- 1) Rapid self-priming**
Without foot valve up to a height of 7.5 m (24.5 ft)
- 2) High resistance**
To abrasive liquids which are turbid and sandy
- 3) Semi-open impeller**
High thickness casting impact resistant
- 4) Wear plate**
Easily replaceable cast iron wear plate, front to the impeller
- 5) Easy maintenance**
Removable front cover for direct access to the impeller

Applications

Industry:

clean, dirty, sandy, muddy, neutral, alkaline, acidic liquids; low viscous petroleum products, solvents even if dirty; milk of lime, caustic soda; washing, cooling, recirculation, smoke scrubbing.

Treatment:

pumping polluted corrosive wastewater containing sand, mud or solids in suspension; dosing neutralizing liquids; pumping out settled sludge.

Naval:

loading and unloading; bilge pumping; washing, fire-fighting, stripping, sanitary duty and circulation.

Agriculture:

surface irrigation; liquid manure oxygenation; transfer and spraying liquid manure or fertilizers; distribution of liquid animal feed; transfer of wine must; washing.

Varisco S.r.l. has certified its Quality, Environment and Safety Management System in accordance with the requirements of the international standard ISO 9001-14001-45001, recognized by the Lloyd Register.

JX 1-180 T10 NT20



PERFORMANCE CURVES

Test according to **UNI EN ISO 9906 standard - level 2B**
 Test liquid: **clean water, density 1.000 kg/m³**
 Spherical solids handling: **D.11 mm (0.4")**

Priming time (2,900 rpm): **26s from 1,5 m (5 ft)**
 Installed power: **4 kW - 5,5 HP (2900 rpm)**

Noise Curve

dB(A)=max noise level at 1 m

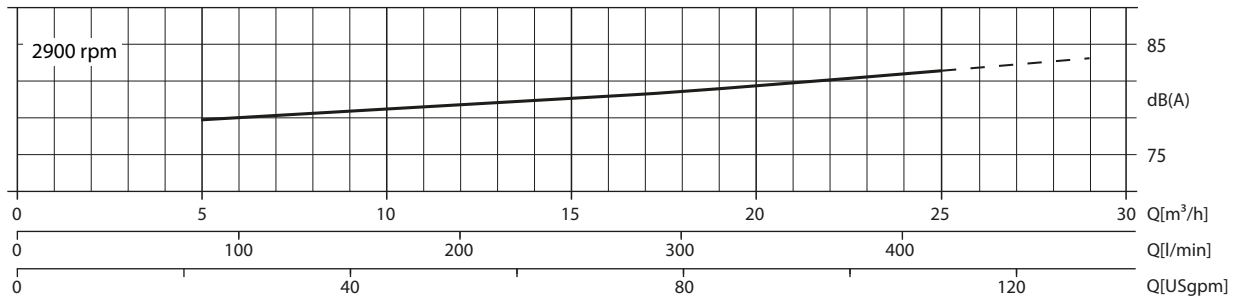

Multiple Speed Curve

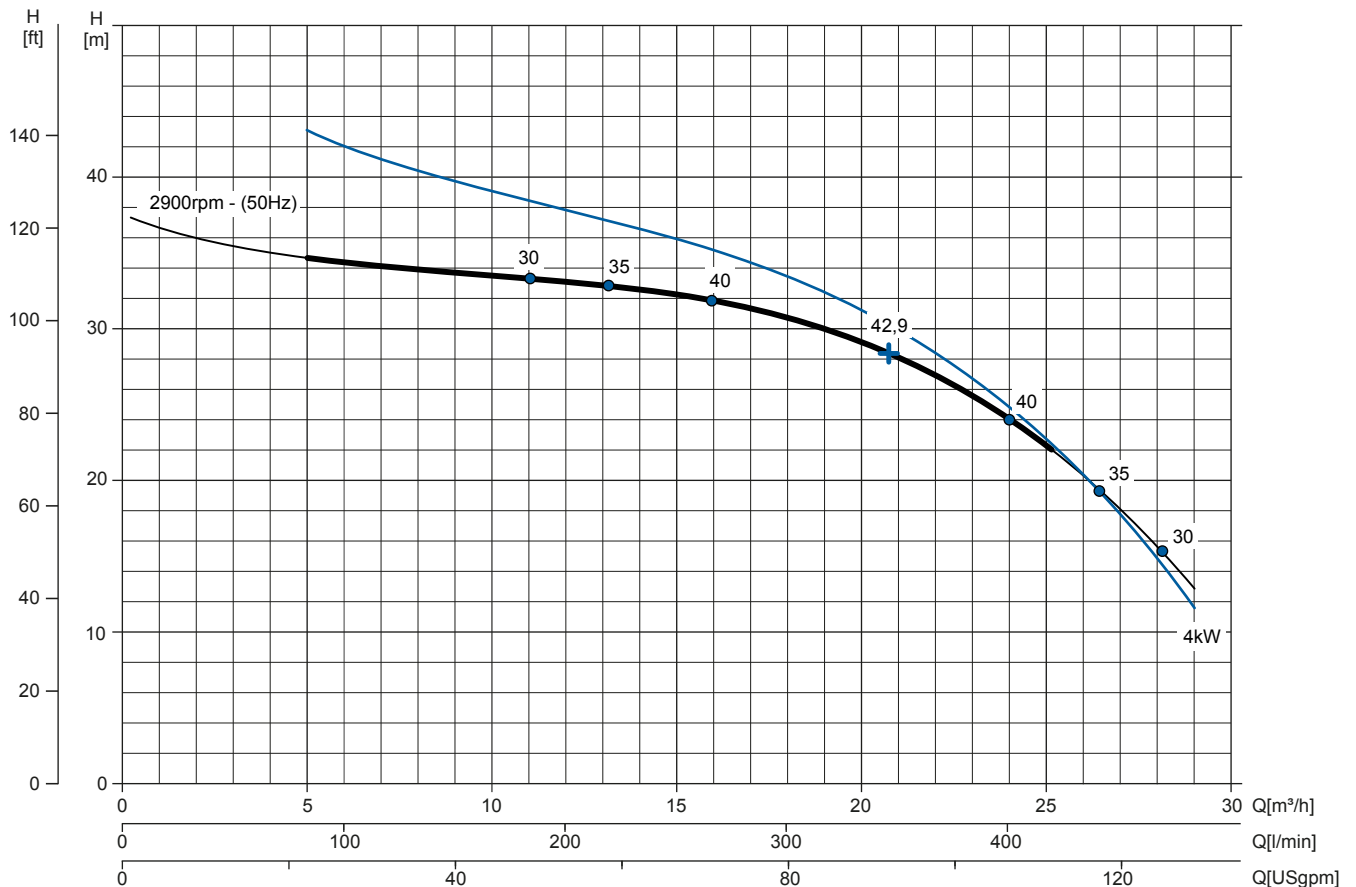

NPSHr Curve

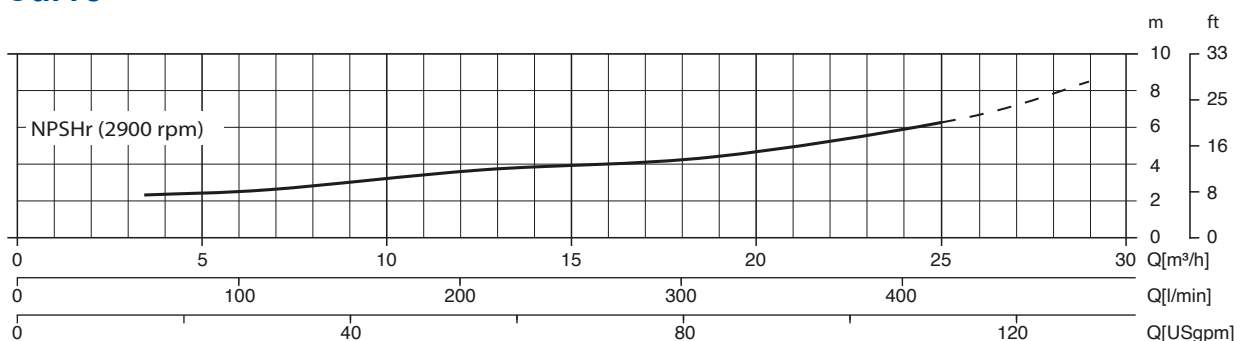

JX 1-180 T10 NT20



TECHNICAL DATA

Pump

Pump model	J1-180
Qmax [2,900 rpm]	25 m³/h - 416 l/min (110 USgpm)
Hmax [2,900 rpm]	37 m (121 ft)
Suction port	Threaded - 1 1/2" ISO 228 (BSP)
Delivery port	Threaded - 1 1/2" ISO 228 (BSP)
Impeller type	Semi-open, 4 vanes
Solids handling	11 mm (0.4")
Casing	EN 1561 EN-GJL-200 cast iron + QPQ
Impeller	EN 1563 EN-GJS-500 cast iron + QPQ
Wear plate	EN 1561 EN-GJL-200 cast iron + QPQ
Non-return valve	Check-valve, NBR
Shaft	C45E EN 10083-2 steel
Mechanical seal	Silicon carbide / Silicon carbide
Elastomers	NBR
Lubrication	Liquid
Thermocouple	"J" type - Temperature range from 0° up to 300°C
Oiler	Glass - Capacity 140 cc

QPQ: type of nitrocarburizing case hardening that increases corrosion resistance, made in three steps; nitrocarburize+oxidize, polish, and post-oxidize

Motor

Mains supply (Three-phase)	220 VD/380 VY ± 5%	230 VD/400 VY ± 5%	240 VD/415 VY ± 5%
Frequency (Nominal speed)	50 Hz ± 2% / 2,900 rpm		
Absorbed current	7,5 A (Y)	7,27 A (Y)	7,03 A (Y)
Starting Current Is/In	7.4	7.7	8
Efficiency (100%)	88,1% (IE3)	88,1% (IE3)	88,1% (IE3)
Model	CEMP		
Standards	IEC 60034-1		
Construction	cast iron, TEFC		
Mounting arrangement	IM 2101 B34		
No. poles	2		
Rated power	4 kW - 5,5 HP		
Degree of protection	Ex-db IIB T4 Gb / IP55		
Markings	CE		
Insulation class/Temperature	F/80°K		
Duty type	Continuous - S1		
Temperature sensors	PTC, available as option		

Arrangement

Model	Close-coupled N
Dimensions	340 x 726 x 394 mm (13 x 28,5 x 15,5")
Coating	Polyurethane enamel, average thickness of 100 µm
Color	RAL 5010 blue (standard)
Features	Close-coupled with rigid coupling "N"
Height connection	0.2 m (10")

Optionals

Flanged ports DN40 PN16 EN1092-2 Type B	cod. 10042259
Flanged ports 1"1/2 ANSI B16.1 Class 125 R.F.	cod. 10042817

Weight

Net weight	110 kg (243 lb)
------------	-----------------

JX 1-180 T10 NT20



DIMENSIONS

mm [in]

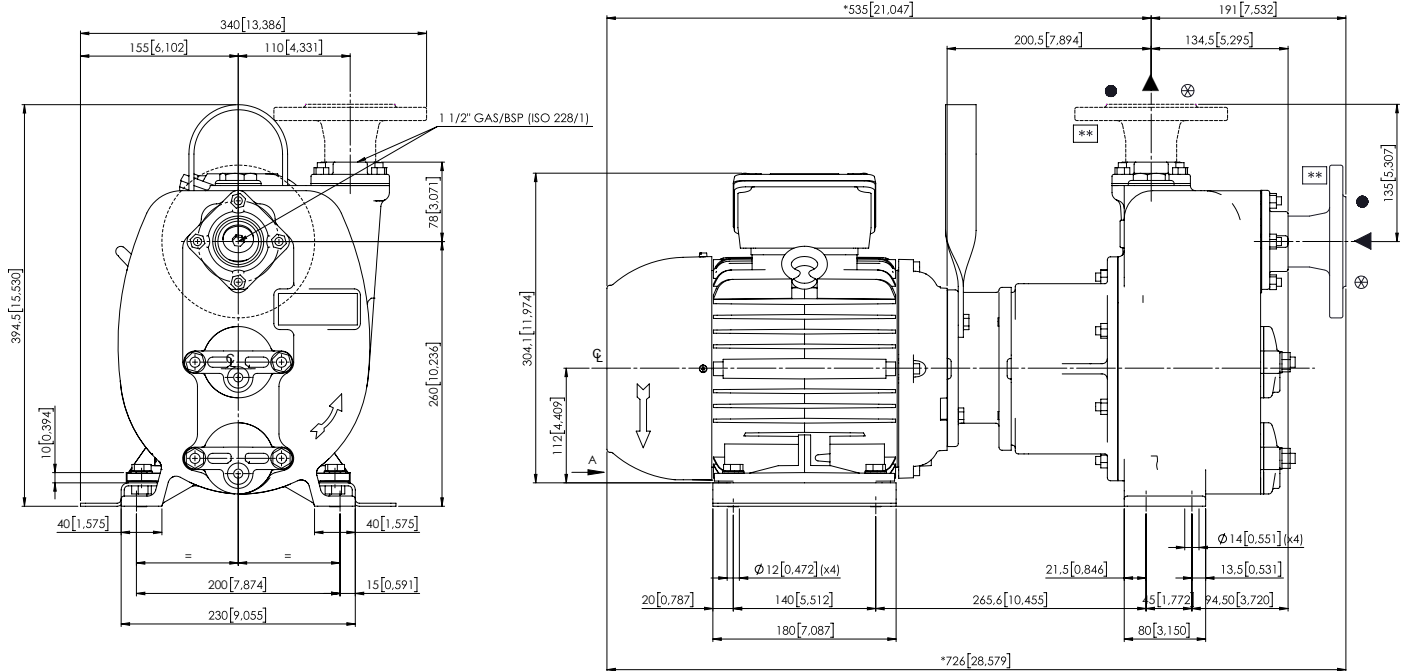

FLANGIATURA SU RICHIESTA / FLANGES ON REQUEST

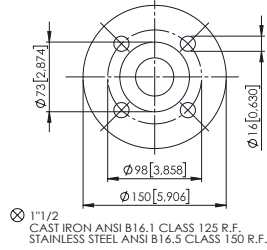
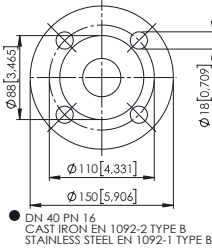

VIEW A

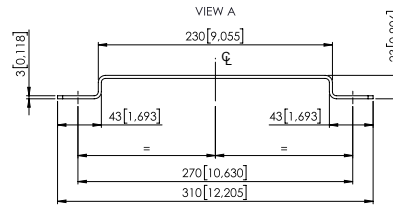

PACKAGING DIMENSIONS

Dimensions

JX 1-180 T10 NT20 (L x W x H mm)

720 x 270 x 480 + BOX

Gross weight (pump + packing)

117 kg (257 lb)

