

JE 2-120 G20 NT20

Electric - Qmax 44 m³/h - (193 USgpm) - Hmax 20 m (65 ft)

Code 8381064116

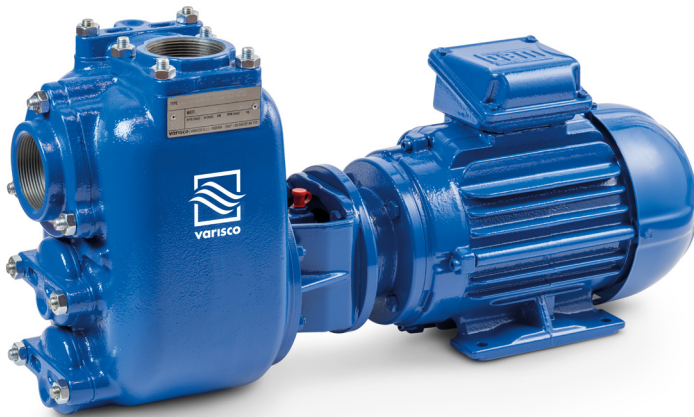

Indicative picture of the product

Product Data

Suction port
Threaded - 2" ISO 228 (BSP)

Delivery port
Threaded - 2" ISO 228 (BSP)

Qmax
44 m³/h - 733 l/min (193 USgpm)

Hmax
20 m (65 ft)

Solids handling
25 mm (1")

Motor power
2.2 kW - 3 HP

Motor type
IEC standard
Winding for inverters
Cast iron frame

Motor brand
WEG W22 Premium

Weight
60 kg (132 lb)

Close-coupled self-priming centrifugal pump with electric motor

Characteristics

The J series self-priming centrifugal pumps are used in applications where a rapid priming capacity is required from demanding suction heights combined with the ability to transfer and manage polluted fluids, dirty and abrasives with suspended large diameter solids. The system is based on an inspectable pump casing which also acts as a water tank allowing a first quick priming without auxiliary systems, simplifying management of the system and reducing the time for maintenance. Within the physically permitted suction height limits, J pumps are a more comfortable and reliable solution than submersible pumps and vertical submersed impeller pumps.

Benefits

- 1) Rapid self-priming**
Without foot valve up to a height of 7.5 m (24.5 ft)
- 2) High resistance**
To abrasive liquids which are turbid and sandy
- 3) Semi-open impeller**
High thickness casting impact resistant
- 4) Wear plate**
Easily replaceable cast iron wear plate, front to the impeller
- 5) Easy maintenance**
Removable front cover for direct access to the impeller

Applications

Industry:

clean, dirty, sandy, muddy, neutral, alkaline, acidic liquids; low viscous petroleum products, solvents even if dirty; milk of lime, caustic soda; washing, cooling, recirculation, smoke scrubbing.

Treatment:

pumping polluted corrosive wastewater containing sand, mud or solids in suspension; dosing neutralizing liquids; pumping out settled sludge.

Naval:

loading and unloading; bilge pumping; washing, fire-fighting, stripping, sanitary duty and circulation.

Agriculture:

surface irrigation; liquid manure oxygenation; transfer and spraying liquid manure or fertilizers; distribution of liquid animal feed; transfer of wine must; washing.

Varisco S.r.l. has certified its Quality, Environment and Safety Management System in accordance with the requirements of the international standard ISO 9001-14001-45001, recognized by the Lloyd Register.

JE 2-120 G20 NT20

PERFORMANCE CURVES

Test according to **UNI EN ISO 9906 standard - level 2B**
 Test liquid: **clean water, density 1.000 kg/m³**
 Spherical solids handling: **D.25 mm (1")**

Priming time (2.900 rpm): **26s from 1,5 m (5 ft)**
 Installed power: **2.2 kW - 3 HP (2900 rpm)**

Noise Curve

dB(A)=max noise level at 1 m

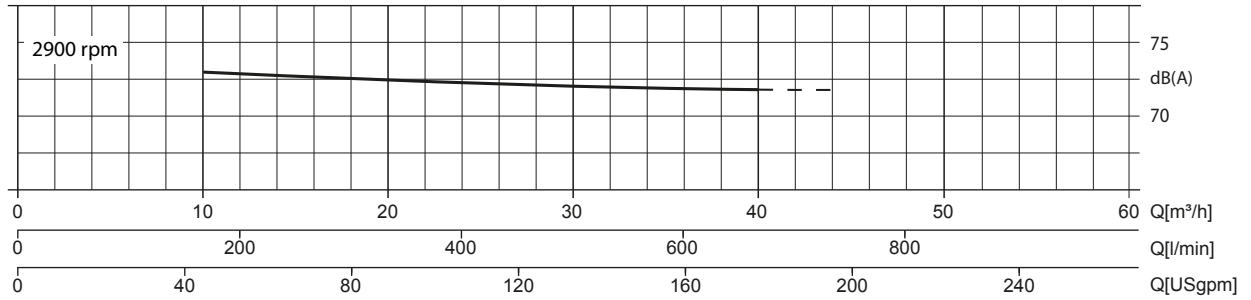

Multiple Speed Curve

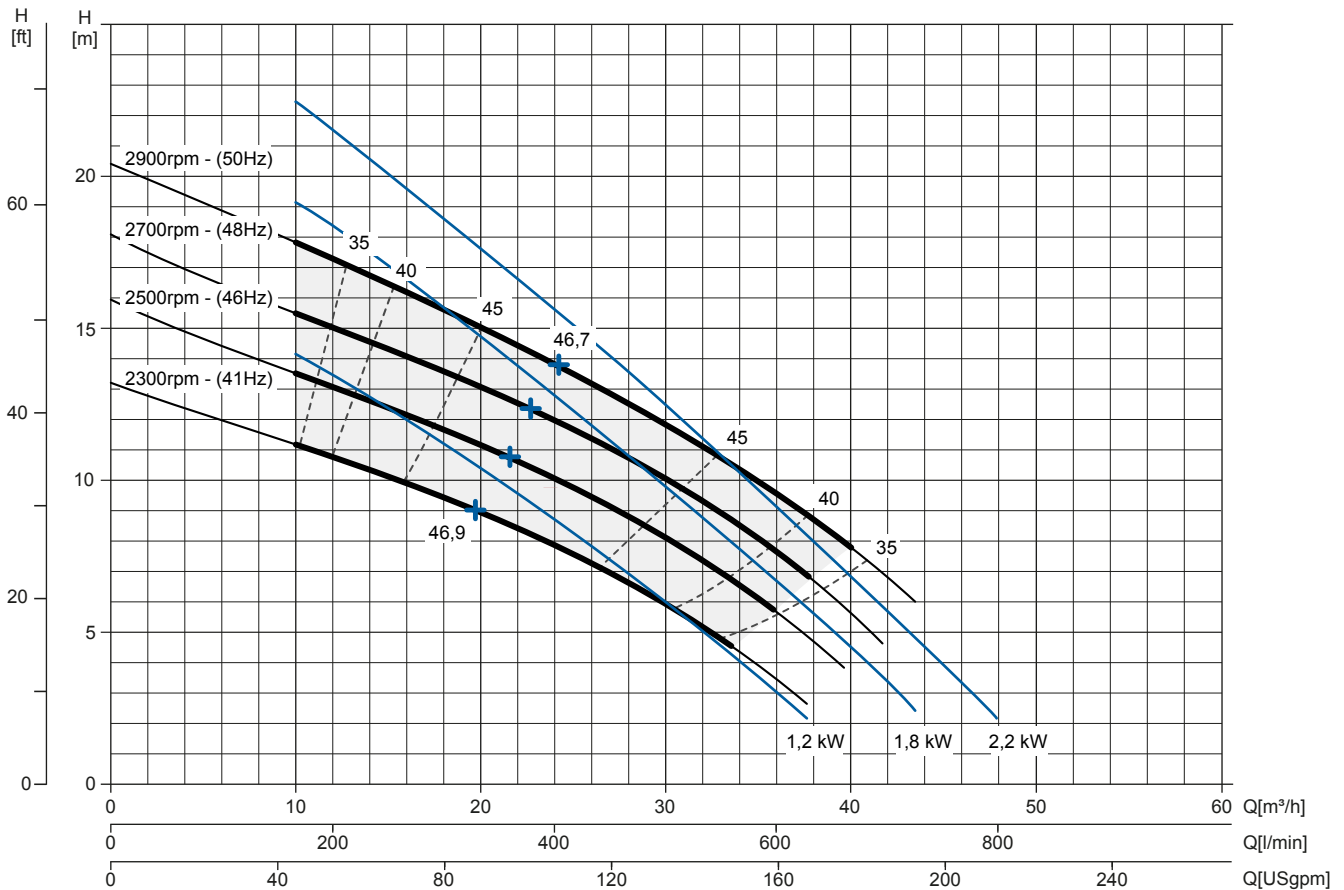

NPSHr Curve

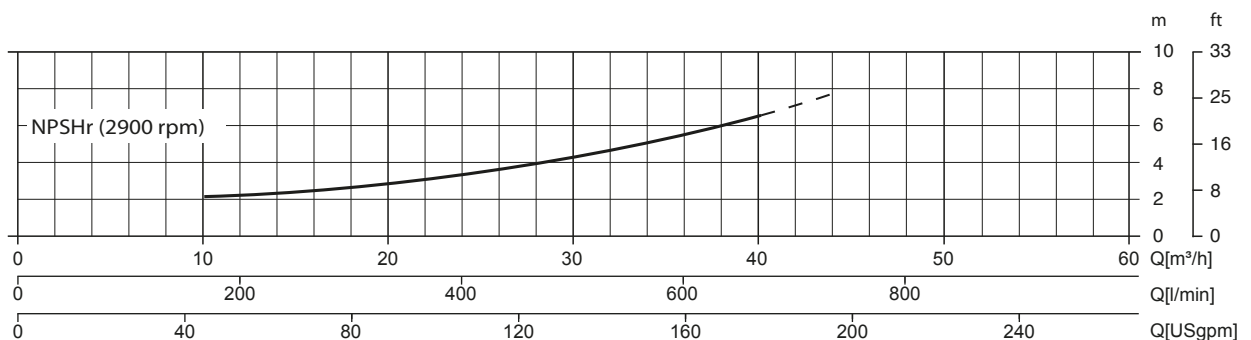

JE 2-120 G20 NT20

TECHNICAL DATA

Pump

Pump model	J 2-120 G20
Qmax [2.900 rpm]	44 m³/h - 733 l/min (193 USgpm)
Hmax [2.900 rpm]	20 m (65 ft)
Suction port	Threaded - 2" ISO 228 (BSP)
Delivery port	Threaded - 2" ISO 228 (BSP)
Impeller type	Semi-open. 3 vanes
Solids handling	25 mm (1")
Casing	EN 1561 EN-GJL-200 cast iron
Impeller	EN 1561 EN-GJL-200 cast iron
Wear plate	EN 1561 EN-GJL-200 cast iron
Non-return valve	Check-valve. PTFE
Shaft	C45E EN 10083-2 steel
Mechanical seal	Carburo di Tungsteno / Silicon carbide
Elastomers	PTFE
Lubrication	Grease

Motor

Mains supply (Three-phase)	220 VD/380 VY ± 5%	230 VD/400 VY ± 10%	240 VD/415 VY ± 5%
Frequency (Nominal speed)	50 Hz ± 3% / 2.900 rpm		
Absorbed current	7.91/4.58 A	7.75/4.45 A	7.56/4.37 A
Starting Current Is/In	7.1	7.5	8
Efficiency (100%)	85.9% (IE3)	85.9% (IE3)	86.5% (IE3)
Model	WEG W22 Premium		
Standards	IEC 60034-1		
Construction	Cast iron. TEFC		
Mounting arrangement	IM 2101 B34		
No. poles	2		
Rated power	2.2 kW - 3 HP		
Degree of protection	IP55		
Markings	CE. UL. CSA. EAC		
Insulation class/Temperature	F/80°K		
Duty type	Continuous - S1 Variable - suitable for inverter use (30-50 Hz)		
Temperature sensors	PTC, available as option		

Arrangement

Model	Close-coupled N
Dimensions	190 x 596 x 291 mm (7.5 x 23.5 x 11.5")
Coating	Polyurethane enamel, average thickness of 100 µm
Color	RAL 5010 blue (standard)
Features	Close-coupled with rigid coupling "N"
Height connection	0.2 m (0.7 ft)

Optionals

Flanged ports DN50 PN16 EN1092-2 Type B	Cod. 10042783
Flanged ports 2" ANSI B16.1 Class 125 R.F.	Cod. 10042818
Automatic mechanical seal greaser	Cod. 10008316
Integrated VSD motor inverter	Available by 2021

Weight

Net weight	60 kg (132 lb)
------------	----------------

JE 2-120 G20 NT20

DIMENSIONS

mm [in]

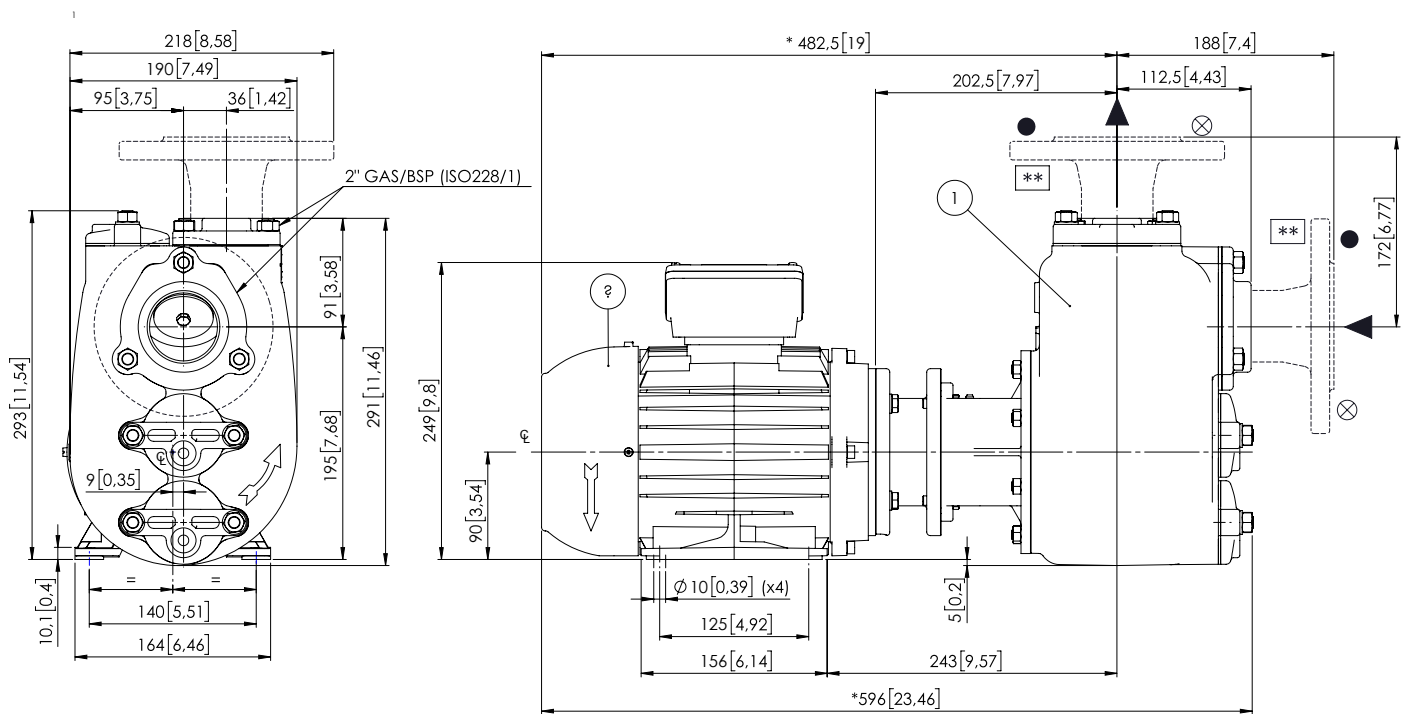

FLANGIATURA SU RICHIESTA / FLANGES ON REQUEST

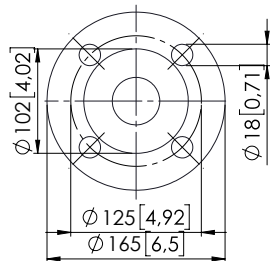

● DN 50 PN 16
CAST IRON EN 1092-2 TYPE B
STAINLESS STEEL EN 1092-1 TYPE B

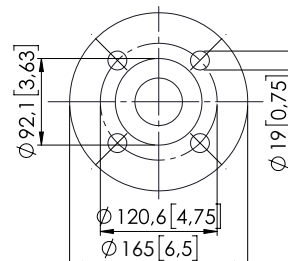

⊗ 2" CAST IRON ANSI B16.1 CLASS 125 R.F.
STAINLESS STEEL ANSI B16.5 CLASS 150 R.F.

PACKAGING DIMENSIONS

Dimensions

JE 2-120 G20 NT20 (L x W x H mm)

720 x 270 x 480 + BOX

Gross weight (pump + packing)

64 Kg

